

kreon installation manual

technics & dimensions

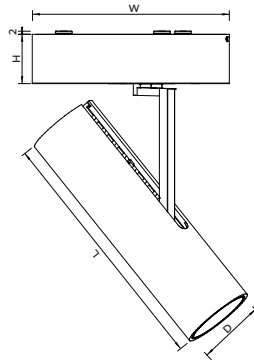

name	reference	voltage VAC	frequency	led current	nom. current driver	max. power	power factor	WxHxLxD
Holon 40 dir single surf. mounted gear incl	KR96250X-90XX-XX-PD	230V	50/60Hz	700mA	0,1A	9,1W	0,92	ø120x30x152,5x45

1. light source/gear information

light source containing product

The light source contained in this luminaire shall only be replaced by the manufacturer or his service agent or a similar qualified person.

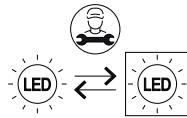

Energy Efficiency Class and EPREL-information for each specific LED/fixture can be found on the last page of this manual

gear containing product

the gear contained in this luminaire shall only be replaced by the manufacturer or his service agent or a similar qualified person

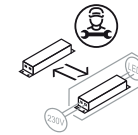

Please make sure the main voltage is disconnected before proceeding! ⚡

2. installation

supply power from ceiling

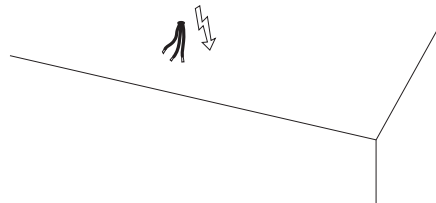

unscrew backplate

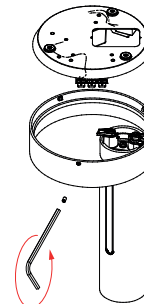

use backplate to mark the 3 installation holes

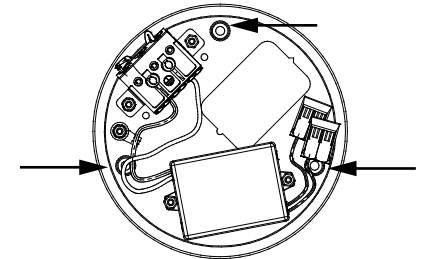

kreon installation manual

3. installation

drill 3 holes according to pattern

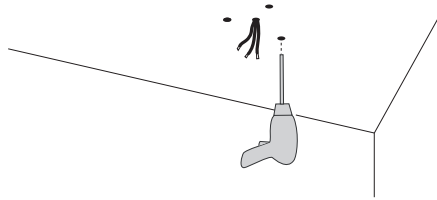

insert plugs (not included)

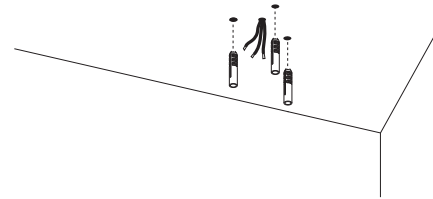

screw backplate to ceiling
(screws not included)

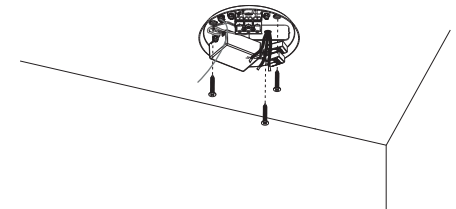

4. installation

If needed the wires from holon can be disconnected

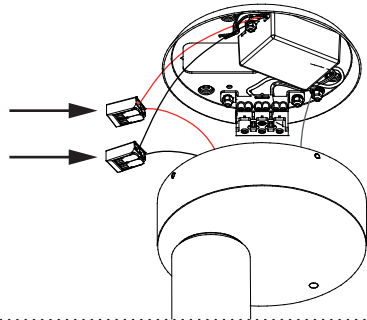

Connect the wires(230VAC) N(blue), L(brown)
and earthing wire to the connector

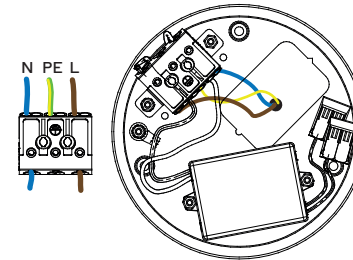

If disconnected earlier, connect the wires from
the led to the driver: black (-) and red (+)

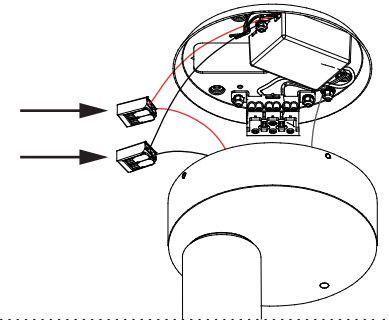

5. installation

Mount the top part on the back plate:
see next steps for detailed information

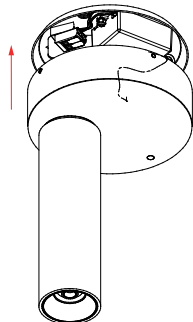

The metal pins inside the top part should
hang on the edge of the back plate

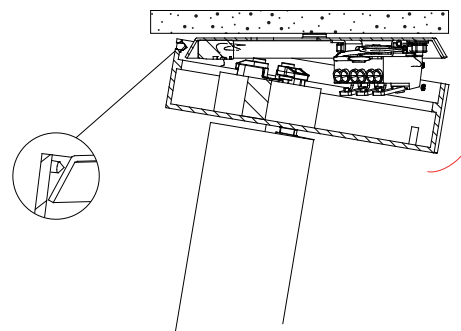

Close the fixture by mounting the screw back
until fixture is fixed

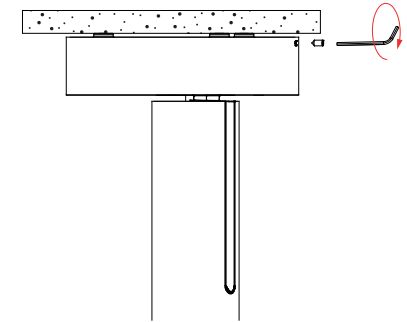

kreon installation manual

6. installation

Finished installation
There is a shadowgap between fixture and wall

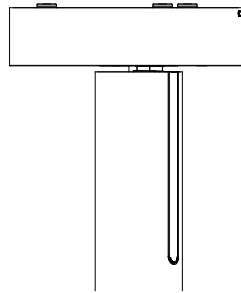

holon can be inclined in an angle up to 90°
and can be rotated 330°

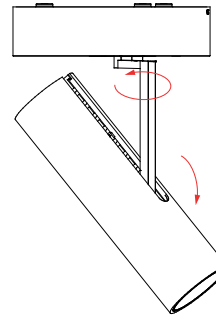

7. accessories

only for holon with extension SP, FL and WFL
in case of accessories
check maual KR8622102021 delivered with accessory

KR762000

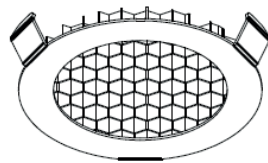



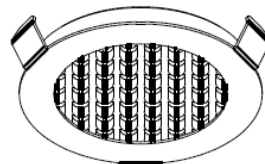

KR762200



pictures

kreon light source information

Fixture reference	LED reference	Energy Efficiency Class	QR-code	EPREL link
KR96250x-9027-SP-PD KR96250x-9027-DL-PD KR96250x-9027-WDL-PD	KR7000104041	TBD		https://eprel.ec.europa.eu/qr/XXXXXXX
KR96250x-9027-FL-PD KR96250x-9027-WFL-PD	KR7000104033	TBD		https://eprel.ec.europa.eu/qr/XXXXXXX
KR96250x-9030-SP-PD KR96250x-9030-DL-PD KR96250x-9030-WDL-PD	KR7000104042	TBD		https://eprel.ec.europa.eu/qr/XXXXXXX
KR96250x-9030-FL-PD KR96250x-9030-WFL-PD	KR7000104034	TBD		https://eprel.ec.europa.eu/qr/XXXXXXX

kreon light source information

replacement parts

